

Article number: 0101175
 Description: Retaining ring A 255 DIN 471
 Spring steel
 Note: Fitted with ZGA pilers

Measures

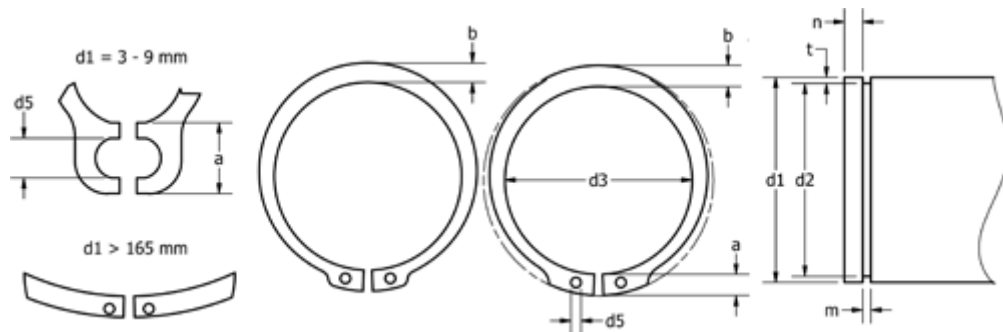

a max	= 16.2	FN kN	= 525.0	s	= 5.00
AN mm ²	= 3150.0	FRg kN	= 55.70	t	= 4.00
b	= 16.0	FR kN	= 557.00	tol	= -0.72
d1	= 255	g	= 6.0	tol	= -0.12
d2	= 247.0	K kN-mm	= 1276.00	tol	= +0,72-1,70
d3	= 240.0	m min	= 5.15	Tong	= ZGA-6
d5 min	= 5.0	n abl x 1000	= 1.0	Weight kg/1000	= 348.000
Description	= A255	Nominal drive	= 12.0		